

# Nexon.ev

game — changer







# game — changing design

A stunning new design that  
commands attention.



## smart digital DRLs

Make your presence felt through the signature DRLs with welcome and goodbye sequence and charging indicator.



## smart digital X factor

The iconic X factor with a welcome and goodbye sequence lends a sleek digital look.



## hidden rear wipers

Better coverage for better visibility.



## digital dashboard

A dynamic digital dashboard that elevates your cabin experience.



## R16 alloy wheels

Glide through with aero inserts on R16 alloy wheels.

## smart digital steering wheel

Stylish 2-spoke back-lit steering wheel.



## phygital control panel

Touch meets digital control.



## smart digital shifter

Seamless drive selection for quick responsiveness.



for —  
different  
personas



Your unique personality will now  
reflect in your car.

# empowered —

For those who are always driven to make a difference.





# fearless

For those with an unflinching,  
unshakeable belief in themselves  
that inspires others.



# creative

For those who always bring a unique and original perspective, expressing it in all its forms.





# game — changing innovation

Reimagine what your car can do.

# V2V charging



Charge another EV, anywhere with vehicle-to-vehicle charging<sup>^^</sup>.



## V2L technology\*\*\*

Power your gadgets with the power of your EV.



Reimagine your car as a power bank.



Never out of power to suit your lifestyle.

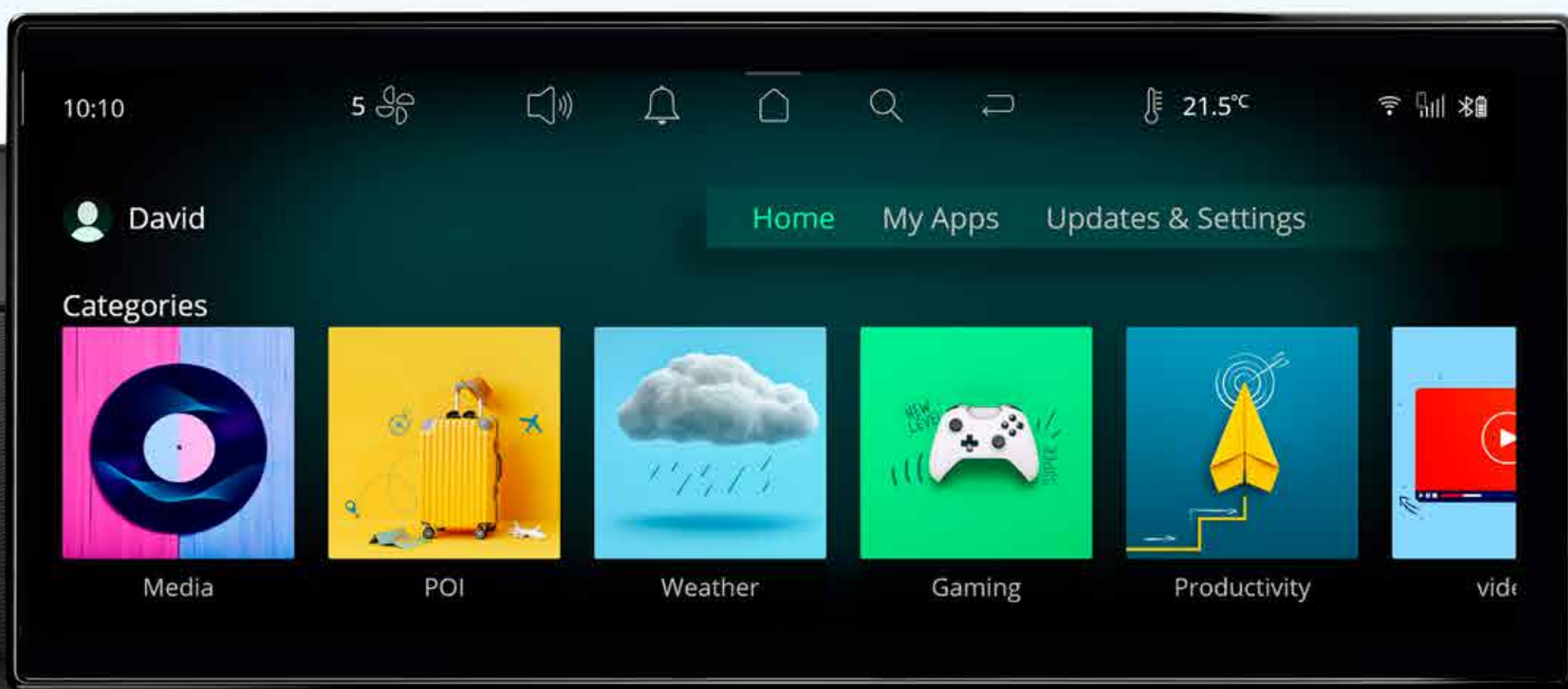

## Arcade.ev\*\*

A true app suite to download your favourite music, video, productivity, navigation and gaming apps.

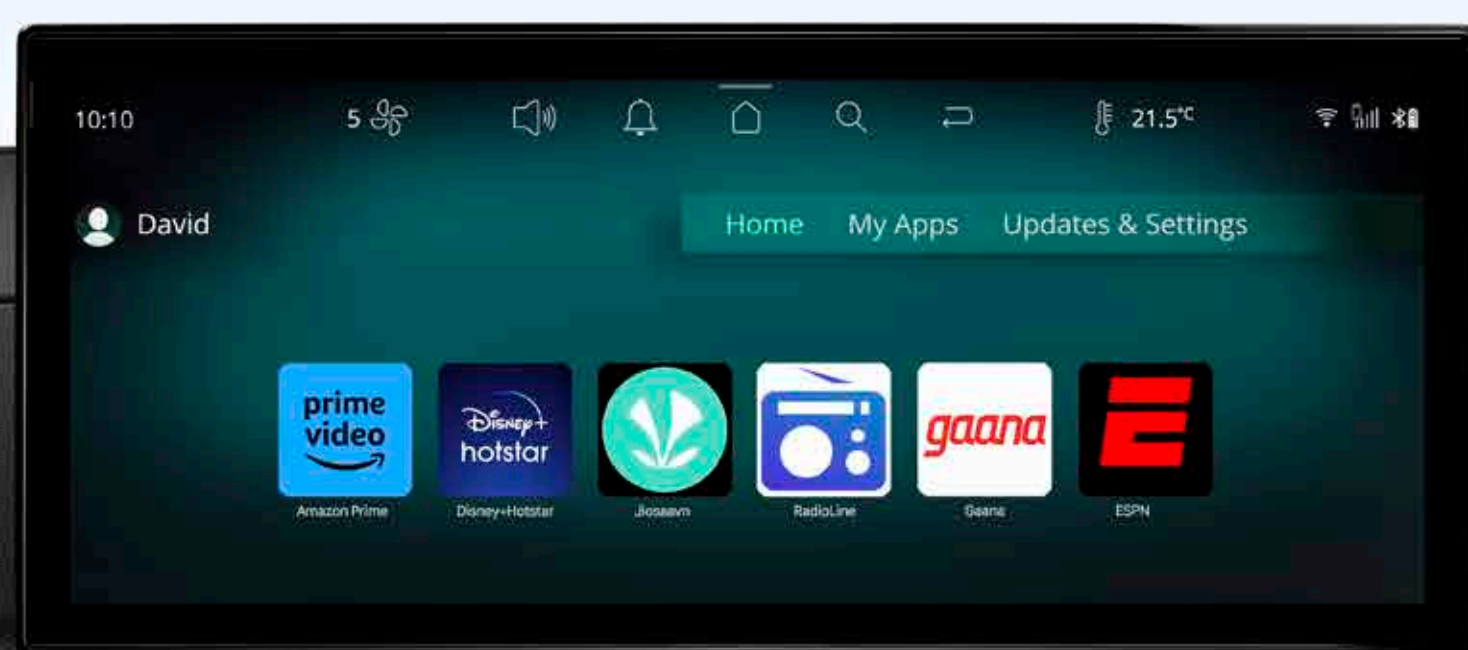

15+ apps today and more tomorrow.

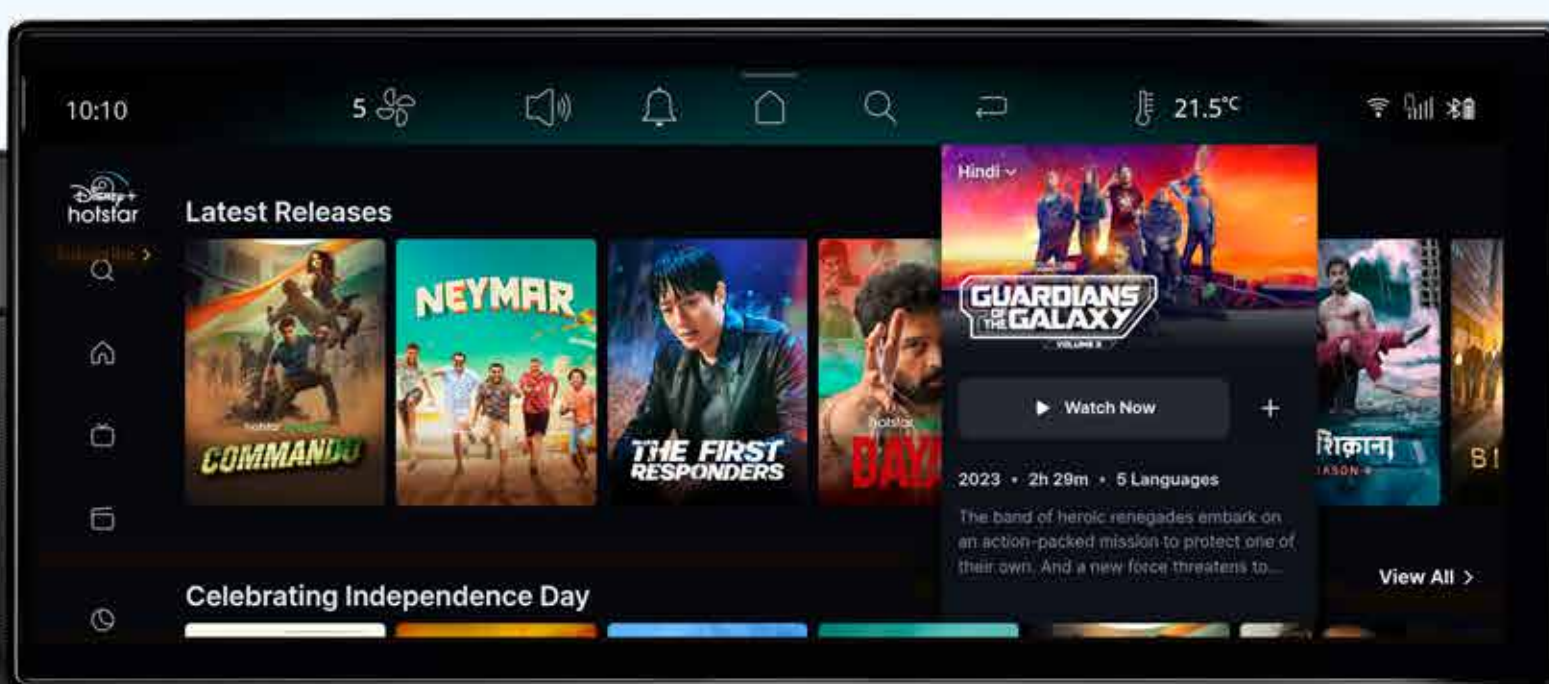

Imagine watching your favourite OTT series in your all-new Nexon.ev.



# game — changing technology

The next big thing in tech is already here. Are you game?

# 31.24 cm cinematic touchscreen



An immersive, unparalleled cinematic experience awaits you.





## JBL cinematic sound system

Spatial, immersive JBL audio for a 360° 3D surround sound experience.

## high quality speaker

9 high quality speakers including external sub-woofer.



## audio modes

Multiple audio modes that enhance in-vehicle acoustic experience.

## cinematic experience

An immersive experience like no other.



## kids sleeping in back

Stay entertained without disturbing the kids.



## digital cockpit

High-definition fully reconfigurable instrument cluster.



Multi-dial view in cluster.

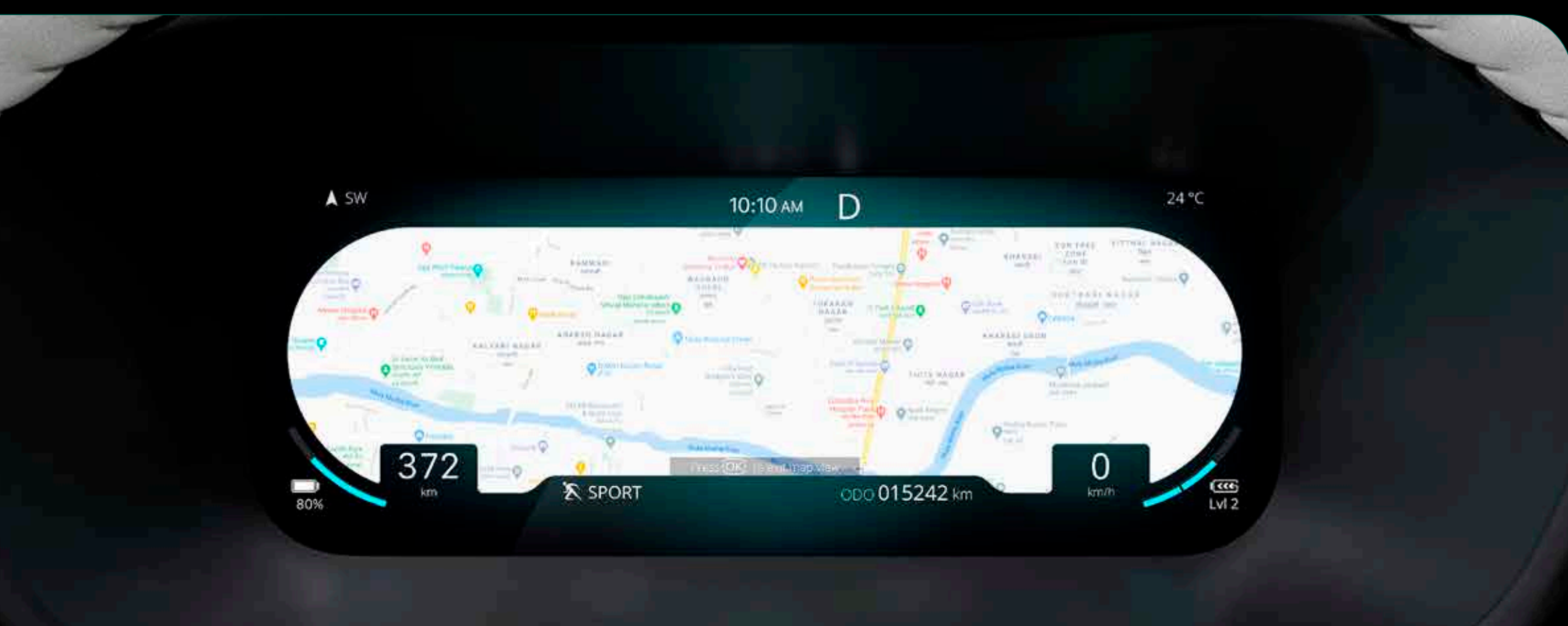

Embedded maps for a safe, intuitive and enriched driving experience.



## wireless charger

Charging with no strings attached.

## wireless Android Auto™ and Apple CarPlay™

Be it Android or Apple, connect wirelessly.



## air purifier

Breathe pure, drive refreshed.

## electronic parking brake

Engage your parking brake with a switch.





## auto dimming IRVM

Don't let the lights behind you blind you.

## OTA updates

Stay new forever with over the air updates.



## rain sensing wiper

Automatic wipers for unexpected rain showers.



## auto headlamps

Automatic headlamps that light up your drives.





# game — changing safety

A new benchmark in safety to keep your family safe and sound.



## SOS call###

In-cabin emergency assistance button.

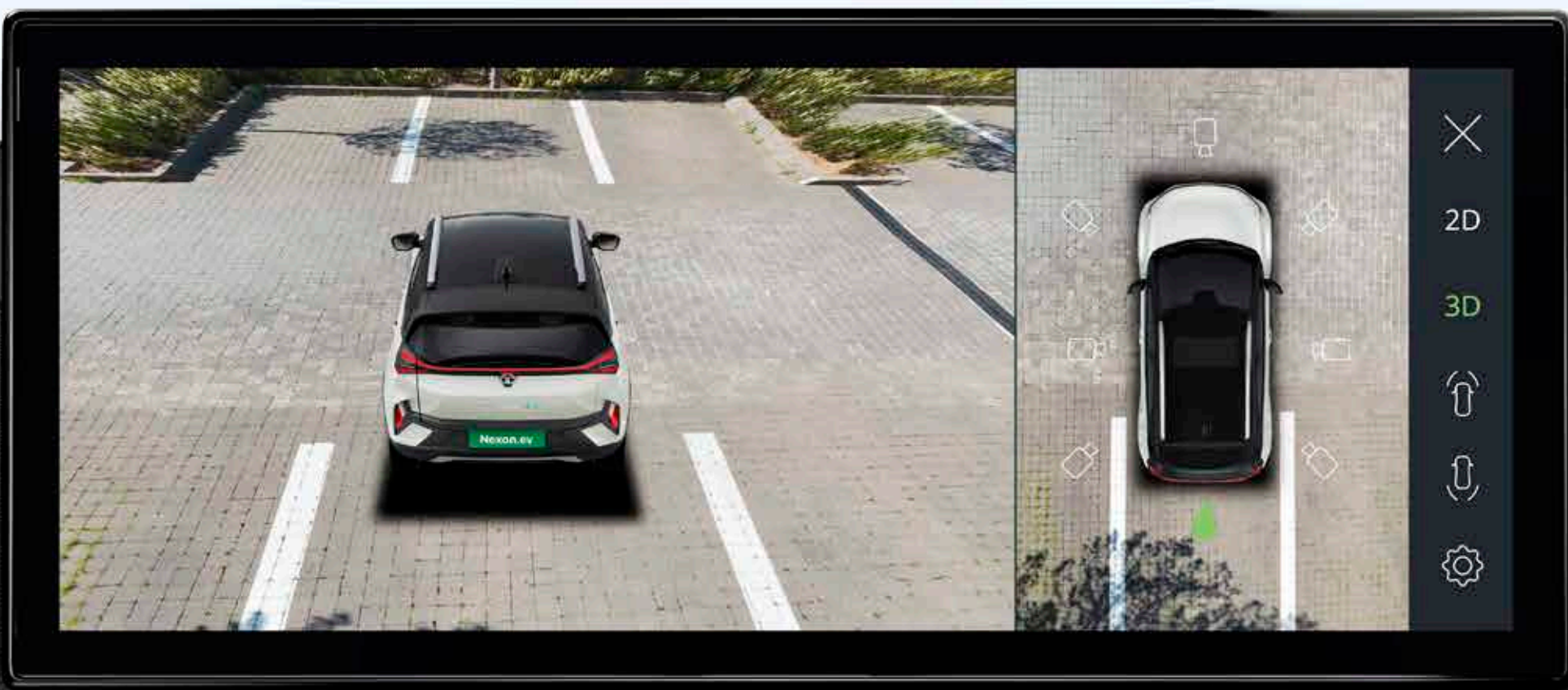

## 360° surround view camera system

Get a 360° view of everything that surrounds you.

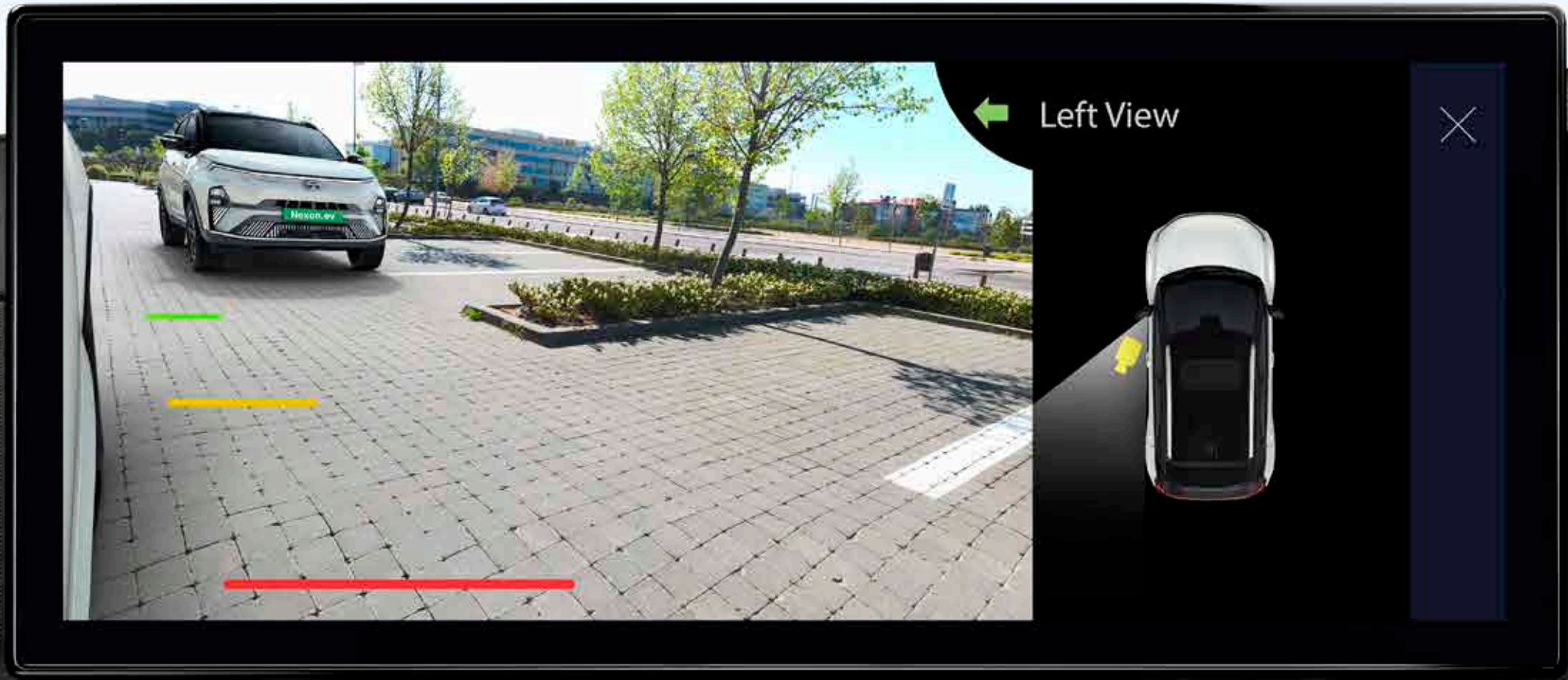

## blind spot view monitor

Additional safety when you need to take a turn.

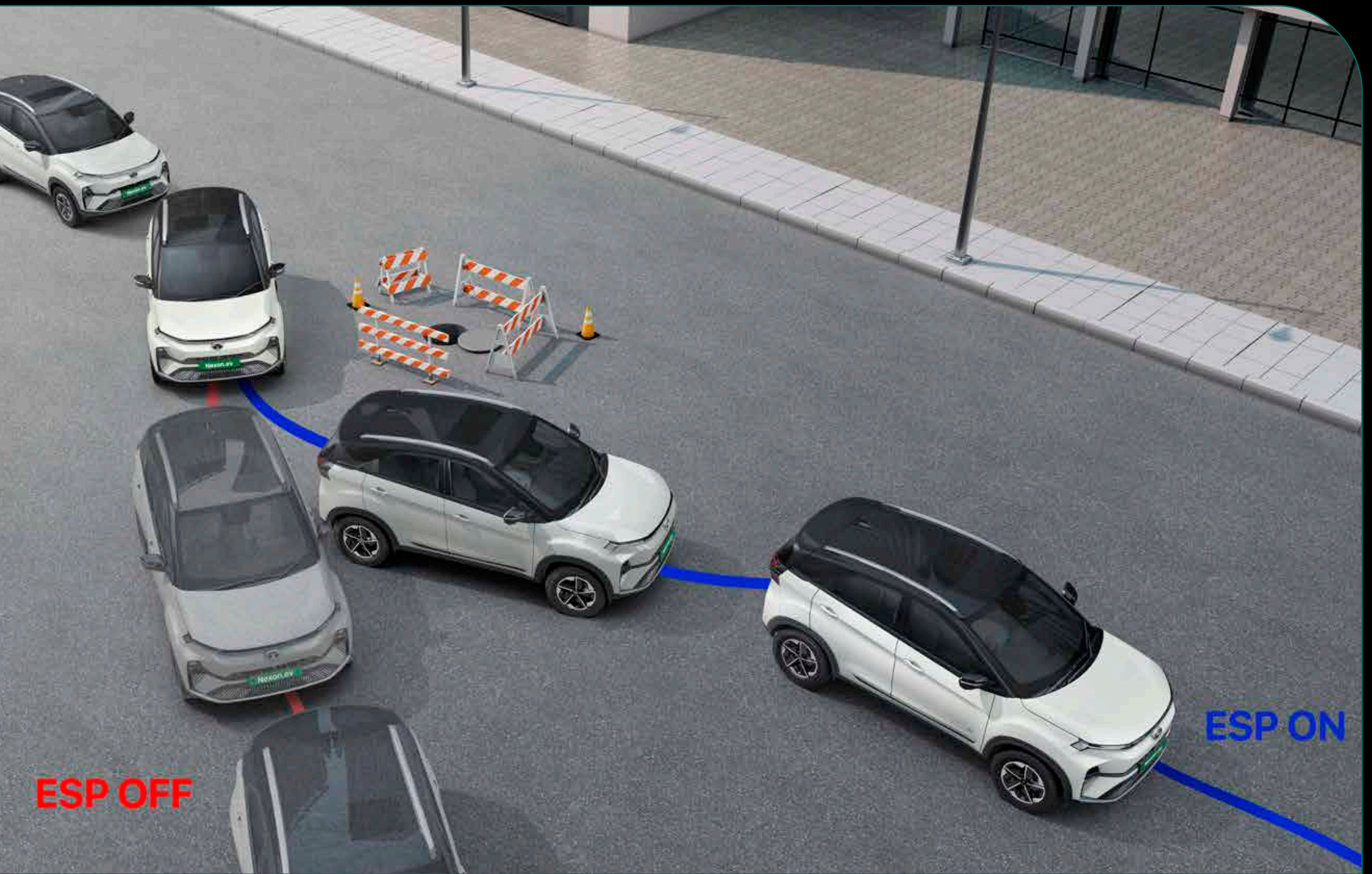

## ESP with i-VBAC

Advanced dynamic stability for precise handling.

## 6 airbags

All-round safety for all-round peace-of-mind.



## hill ascent control

Holds for 2 seconds when you stop on an incline offering more time to control.

## hill descent control

Control your car's speed on slope declines.



## auto hold

Keeps your car at a complete stop until you press the accelerator.



## all disc brakes

Increased braking efficiency, for more control.



## front parking sensor

Parking made easier with front assist sensors.





# game — changing comfort

Slip into a world of plushness & comfort.



## electric sunroof

Open up your sunroof with just your voice.



## grand centre console

Let's take some pressure off those long drives.



## 60:40 rear seats and centre armrest

Customise your comfort and storage.



## boot space

Ergonomic boot space to carry everything you need.

## rear AC vents

Keep passengers in the back as cool and comfortable as you are.



## bolstered ultra comfort seats with ventilation

Extra cushioned seats for extra comfort on drives.

## cooled glove box

For those who like to keep things chill.



## USB type C (45W)

Fast charge your gadgets on-the-go.



# game — changing performance

Elevate your drives with  
gamechanging performance.



## paddle shifters

Enjoy intuitive on-the-go energy regen.



## multi drive modes - eco, city & sport

Whatever your driving style, we've got you covered.

# Nexon.ev — architecture

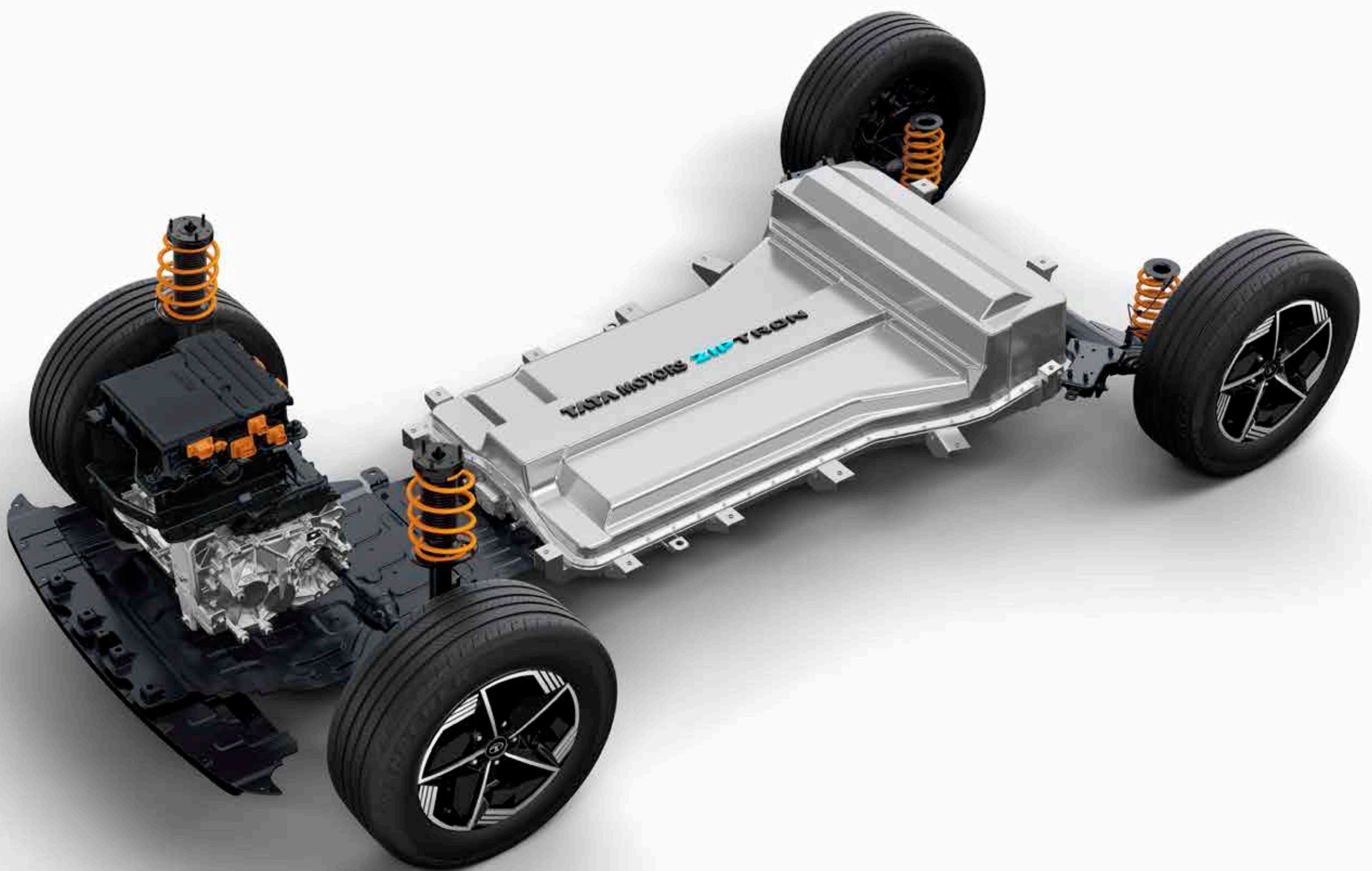

## range

---

Say yes to long drives! 465<sup>#</sup> km in a single charge.

## 0-100 in 8.9<sup>s</sup>

---

Fast when you need it to be.

## power output of 106.4 kW

---

Unleash the power of electric.

## instant torque of 215Nm

---

Instant torque equals instant fun.

## IP67

---

Drive worry-free with high ingress protection standards.

— performance

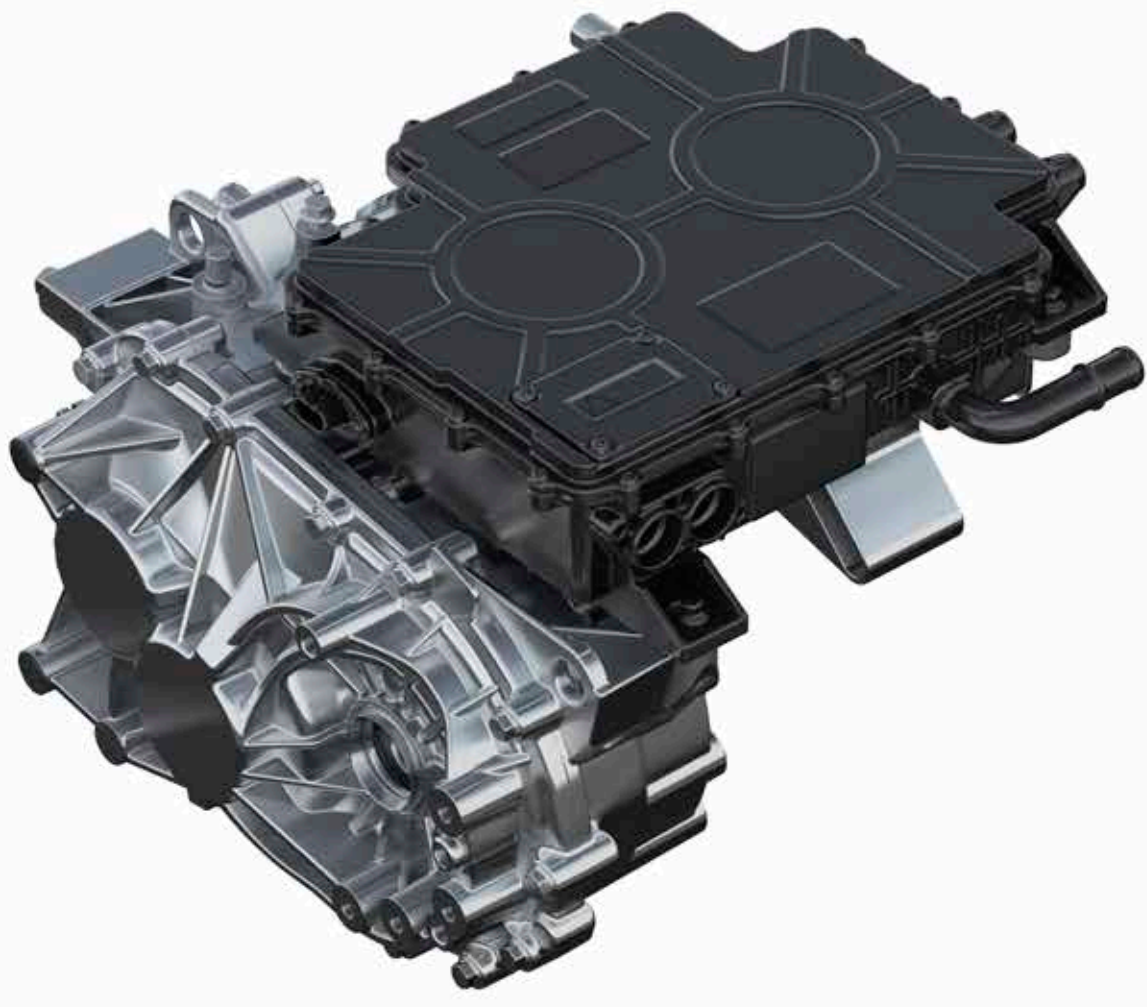

## all-new gen-2 motor

---

Where performance meets efficiency.

## liquid cooled battery pack

---

Long lasting battery, ideally suited for Indian driving conditions.

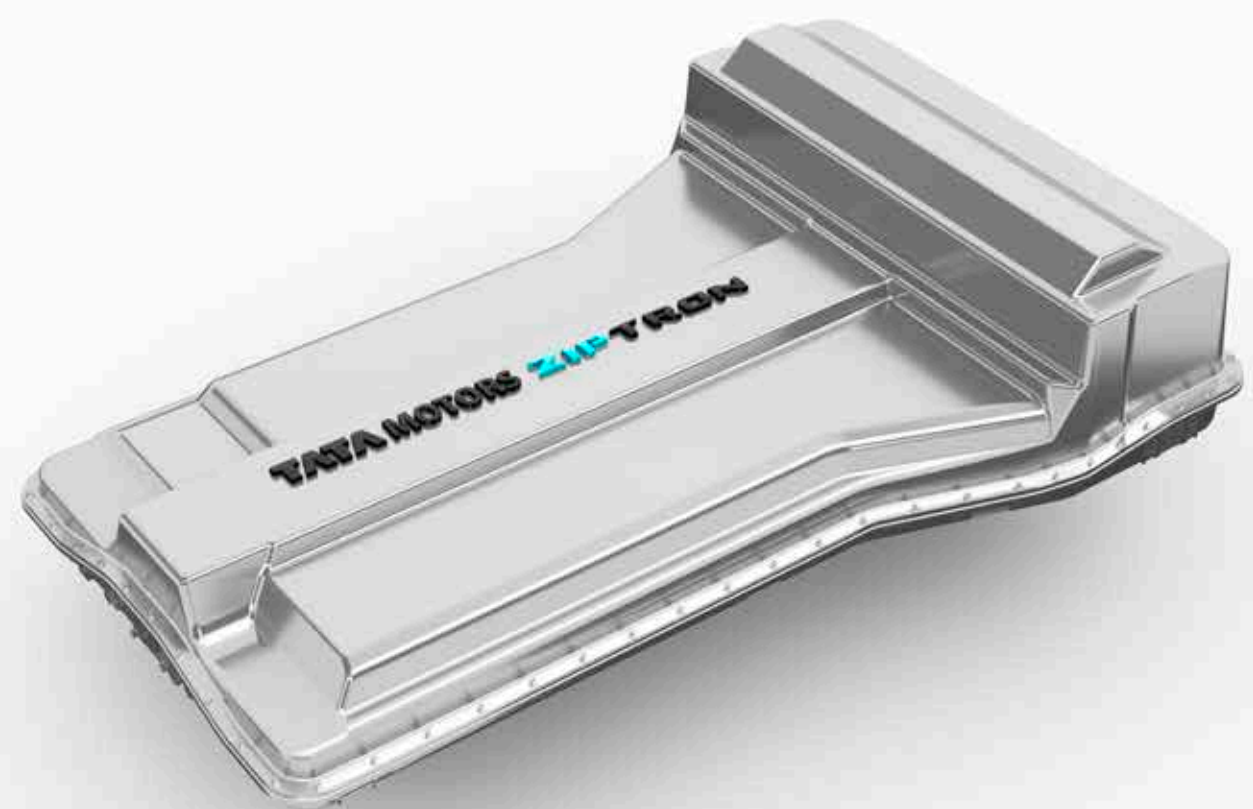

## power electronics

---

Smart algorithms to control vehicle electronics.

# charging —

Enjoy hassle-free drives with multiple charging options.



## home charging

### 7.2kW AC home wallbox charger

Charge conveniently at home. SOC 10% - 100% in 4.3\* hours for Medium Range and 6\* hours for Long Range.

### AC home wallbox charger

Charge efficiently. SOC 10% - 100% in 10.5\* hours for Medium Range and 15\* hours for Long Range.

## on-road charging

### DC fast charger

Charge quickly. SOC 10% - 80% in 56\* minutes for both, Medium & Long Range.

### 15A portable charger

Charge anywhere. SOC 10% - 100% in 10.5\* hours for Medium Range and 15\* hours for Long Range.



# multiple colour choices to pick from

## empowered

pristine white



daytona grey



intensi teal



flame red



empowered oxide



fearless purple

## fearless

pristine white



daytona grey



flame red



## creative

pristine white



daytona grey



flame red



creative ocean

## Nexon.ev - technical specifications and features

	long range	medium range
<b>electric drivetrain</b>		
Motor (Type)	Permanent Magnet Synchronous AC Motor	
Electric Motor Power (kW)	106.4	95
Electric Motor Torque (Nm)	215	
Multi Drive Modes	Multi Drive Modes - Eco, City & Sport	
Battery Pack (kWh)	40.5	30
Thermal Management System	Liquid Cooled System	
Ingress Protection for Motor & Battery Pack	P67	
Acceleration (0-100 km/h in sec)	8.9^	9.2^
Emission	Zero Tailpipe Emission	
<b>smart drive features</b>		
Smart Regenerative Braking	Multi-Mode Regenerative Braking   4 Levels (Level 0 - 1 - 2 - 3) 0 - No Regen   3 - Max Regen	
Paddle Shifters to Control Regen Modes	✓	
Customizable Single Pedal Drive	✓	
<b>dimension</b>		
Length x Width x Height (mm)	3994 × 1811 × 1616	
Wheelbase (mm)	2498	
Unladen Ground Clearance (mm)	190	205
Boot Space (Litre)	350	
<b>steering</b>		
Steering	Electrically Power Assisted	
Turning Circle Radius (m)	5.3	
<b>brakes</b>		
Front, Rear	All - Disc	Front - Disc, Rear - Drum
<b>suspension</b>		
Front Suspension	Independent MacPherson Strut with Coil Spring	
Rear Suspension	Twist Beam with Dual Path Strut	
<b>wheels &amp; tyres</b>		
Size	215 /60 R16 (Make: MRF)	
Low Rolling Resistance Tyres	✓	
<b>charging</b>		
Charging Standard	CCS2	
Portable Charging Cable	Yes	
Charging Options	Home, 3.3 kW AC Wall Box, 7.2 kW AC Wall Box, DC Fast Charger	
Charger Type Included	7.2 kW AC Wall Box	3.3 kW AC Wall Box
Estimated Regular Charging Time (SOC 10% to 100% from any 15A plug point / 3.3 kW AC wall box)	15* hours	10.5* hours
Estimated AC Fast Charging Time (SOC 10% to 100% from 7.2 kW AC Fast Charger)	6* hours	4.3* hours
Estimated DC Fast Charging Time (SOC 10% to 80% from 50 kW DC Fast Charger)	56* minutes	
<b>bi-directional charging</b>		
Vehicle to Vehicle Charging (V2V^^^ Charging)	✓	-
Vehicle to Load Technology (V2L*** Technology)	✓	-
<b>warranty</b>		
Battery Pack and Motor Warranty	8 Year or 1,60,000 km (whichever is earlier)	
Vehicle Warranty	3 Year or 1,25,000 km (whichever is earlier)	
<b>driving range</b>		
Certified Full Charge Range (as per MIDC Cycle) (km)	465#	325#

**creative +  
medium range**

- Smart Digital DRLs
- LED Headlamps
- Smart Digital X Factor
- Smart Digital Shifter
- Smart Digital Steering Wheel
- 6 Airbags
- ESP with i-VBAC
- Camera & Sensor Based Reverse Park Assist
- 17.78 cm Touchscreen Infotainment by HARMAN™
- 17.78 cm TFT Instrument Cluster
- Android Auto™ & Apple CarPlay™
- 4 Speakers
- FATC with Express Cooling
- Push Button Start (PEPS)
- Paddle Shifter for Regen Modes
- Multi Drive Modes - Eco, City & Sport
- Power Window (4 doors)
- Electric ORVM
- Electric Tailgate
- Height Adjustable Seat
- 6.6 kW On-board Charger (Compatible Charging with AC Fast Charger)
- 3.3 kW AC Wall Box
- ZConnect<sup>###</sup> & Smart Watch<sup>^^</sup> Connectivity
- Multiple Voice Assistants (Native, Siri, Google Assistant)

**fearless  
medium range & long range**

addition to creative + medium range

- LED Projector Headlamps
- Centre Position Lamp
- Sequential Indicators
- Front Fog Lamps with Cornering
- Electric ORVM with Autofold
- R16 Alloy Wheels with Aero Inserts
- 26.03 cm Cinematic Touchscreen (Infotainment by HARMAN™ HD)
- 26.03 cm Digital Cockpit
- Navigation in Cockpit - Driver View Maps
- Android Auto™ & Apple CarPlay™ over WiFi
- 4 Speakers + 4 Tweeters
- HD Camera Based Reverse Park Assist
- Hidden Rear Wiper & Washer with Defogger
- Front & Rear Fast Charge C Type 45W
- Rear AC Vents
- Roof Rails
- Cooled & Illuminated Glove Box
- Leatherette Wrapped Steering Wheel
- Alexa Voice Assistant
- V2V<sup>^^</sup> Charging (only long range)
- V2L<sup>\*\*\*</sup> Technology (only long range)
- EPB with Autohold (only long range)
- Rear Disc Brakes (only long range)
- 7.2 kW AC Fast Charger Wall Box (only long range)

**fearless +  
medium range & long range**

addition to fearless

- Arcade.ev<sup>\*\*</sup>
- AudioworX
- Front Armrest
- Cruise Control
- Wireless Smartphone Charger

**fearless +s  
medium range & long range**

addition to fearless +

- Rain Sensing Wipers
- Auto Headlamps
- Voice Assisted Electric Sunroof

**empowered  
medium range**

addition to fearless +s medium range

- Smart Digital Lights
- Welcome & Goodbye Sequence
- Charging Indicator
- JBL Cinematic Sound System (4 Speakers + 4 Tweeters + 1 Subwoofer)
- 360° Camera Surround View System
- Blind Spot View Monitor
- Front Parking Sensor
- Air Purifier with AQI Display
- Auto Dimming IRVM
- Leatherette Seats with Ventilation
- Rear Seat 60:40 Split
- Rear Seat Central Armrest

**empowered +  
long range**

addition to empowered medium range

- 31.24 cm Cinematic Touchscreen (Infotainment by HARMAN™ HD)
- SOS call<sup>###</sup>
- V2V<sup>^^</sup> Charging
- V2L<sup>\*\*\*</sup> Technology
- EPB with Autohold
- Rear Disc Brakes
- 7.2 kW AC Fast Charger